



Operating instructions
LRT Home Essential 11kW
LRT Home Essential 22kW

Manufacturer

LRT Automotive GmbH

Impexstr. 7

69190 Walldorf

Germany

Telephone +49 (0)6227 63692

Fax +49 (0)6227 63792

E-Mail anfrage@lrt.de

URL www.lrt-emobility.de

All rights to this document are owned by LRT Automotive GmbH.

LRT Automotive GmbH reserves the right to make changes or improvements to its products without notice.

Reproduction, excerpt or reference without prior written consent is prohibited.

© 2021

Version	Date of issue	Amendments
1.0	07/05/2021	First edition

Content

1	About this document	4
2	Safety	6
2.1	Intended use	6
2.2	Foreseeable misuse	6
2.3	Safety instructions	7
2.4	Warranty and disclaimer	8
3	Description	8
3.1	Structure	8
3.2	Function	9
3.3	Technical data	9
4	Installation	10
5	Operation	11
6	Maintenance/Cleaning	12
6.1	Testing the safety function	12
6.2	Cleaning	12
7	Disposal	12
8	CE Declaration of Conformity	13

1 About this document

Read the operating instructions before using the charging station. This is a prerequisite for trouble-free use.

Observe the safety instructions and warnings in this documentation.

Keep the documentation accessible to all users.

This documentation is a permanent part of the described product and must be handed over to the buyer at the time of sale.

Scope

The operating instructions apply to the models:

- LRT Home Essential 11kW
- LRT Home Essential 22kW

Target group

The operating instructions are intended for:

- The operator company of the charging station
- The users of the charging station

Qualification of electricians



Installation, maintenance and repair work on the charging station may only be carried out by qualified electricians. They must be trained in the use of a mains connection.

Due to their technical training, knowledge and experience as well as knowledge of the relevant standards and regulations, electricians are able to carry out work on electrical systems and to recognise possible dangers independently.



In Germany, qualified electricians must comply with the provisions of the accident prevention regulation German Social Accident Insurance (DGUV) Regulation 3 (e.g. master electrician). In other countries, corresponding regulations apply and must be observed.

Safety instructions



Structure of safety instructions:



 SIGNAL WORD	Nature and source of the danger
 Warning signs	Consequences of disregarding the danger → Measures to avert the danger → ...

The signal word indicates the level of risk as well as the severity of possible injuries:

Signal word	Meaning
 DANGER	This signal word is used to indicate an imminently dangerous situation which, if not avoided, will result in serious injury or death.
 WARNING	This signal word is used to indicate an imminently dangerous situation which, if not avoided, could result in serious injury or death.
 CAUTION	This signal word is used to indicate an imminently dangerous situation which, if not avoided, could result in minor or moderate injury.
ATTENTION	This signal word without a warning sign is used to indicate a possible danger of property damage.
NOTE	This signal word indicates additional information that is useful for the user, such as such as measures to simplify operation and cross-references.

The warning sign indicates the type of danger.

Warning signs	Meaning
	General warning sign, danger of personal injury
	Warning of electrical voltage

Mandatory signs	Meaning
	Important note, danger of property damage
	Cross-reference
	Information, tip

2 Safety

2.1 Intended use

NOTE



Observe the intended use.

The protection of persons and the charging station is not guaranteed if the charging station is not used in accordance with its intended use.

- Only use the charging station in accordance with its intended use.
- LRT Automotive GmbH is not liable for damage caused by improper use.
- Read these operating instructions before using the charging station. Knowledge of the operating instructions is part of the intended use.

The LRT Home Essential is a three-phase charging station for electric vehicles. This is a stand-alone solution without a higher-level control system. The charging station is used exclusively for charging electric vehicles in accordance with charging mode 3 as per IEC 61851.

Only operate the charging station under the specified operating conditions, see chapter 3.3 Technical data.

The charging station

- is suitable for charging with alternating current (AC).
- has been designed and manufactured according to the international standard IEC 61851.
- meets the requirements of protection class IP44.
- is suitable for outdoor use.
- is intended for use in private areas, e.g. private properties.
- is intended exclusively for stationary installation.

NOTE



Do not use extension cables, cable drums, multiple sockets or adapters to operate the charging station.

2.2 Foreseeable misuse

The charging station may only be operated within the technical data specified by LRT Automotive GmbH. Any use other than that described in chapter 2.1 Intended use is considered improper use. The manufacturer is not liable for any damage resulting from this.

Possible foreseeable misuse:

- Use of extension cables, cable drums, multiple sockets or adapters for the operation of the charging station
- Charging with other charging modes
- Use in the non-private sector
- Use in an environment with aggressive media (e.g. sea air) or highly dusty media (e.g. desert) or in an explosive atmosphere
- Operation outside the specified operating conditions, see chapter 3.3 Technical data
- Modifications or changes to the charging station

2.3 Safety instructions

NOTE



Observe the operating instructions.

Failure to observe the operating instructions and the resulting improper use of the charging station can result in life-threatening personal injury and property damage to the charging station or the vehicle.

- Read the operating instructions before using the charging station.
- Keep the documentation accessible to all users.

DANGER



Warning of dangerous electrical voltage!

Touching electrical cables can result in a fatal electric shock.

- Always keep the charging station housing closed. Only qualified electricians may open the housing.
- Have installation, maintenance and repair work carried out by a qualified electrician only.
- Do not leave children unattended near the charging station while charging is in progress.
- Only use the charging station after it has been commissioned by a qualified electrician.

DANGER



Warning of electromagnetic interference radiation!

Charging stations from LRT Automotive GmbH, which are operated as intended, comply with the European directive on electromagnetic compatibility with regard to interference radiation. In the event that persons with pacemakers or defibrillators wish to carry out activities at charging stations and their equipment, LRT Automotive GmbH cannot make any statement about the suitability of these medical devices.

- LRT Automotive GmbH recommends that affected persons only carry out work on the charging station after consulting the manufacturer of these medical devices.

- Do not store flammable, explosive, chemical or other hazardous substances near the charging station.
- Do not clean the vehicle or the area around the charging station with a pressure washer while the vehicle is connected to the charging station. The plug connection is not resistant to pressurised water.

2.4 Warranty and disclaimer

LRT Automotive GmbH accepts responsibility only for the condition of the charging station as delivered and for all work carried out by LRT specialist personnel and official partner companies.

The manufacturer's warranty is void upon:

- Failure to observe the safety and operating instructions.
- Improper handling and improper use of the charging station.
- Unauthorised and improper installation, maintenance and repair of the charging station.
- Modifications or changes to the charging station.
- Damage caused by fire, flood and other natural disasters.
- Transport damage or damage caused during installation.

3 Description

3.1 Structure

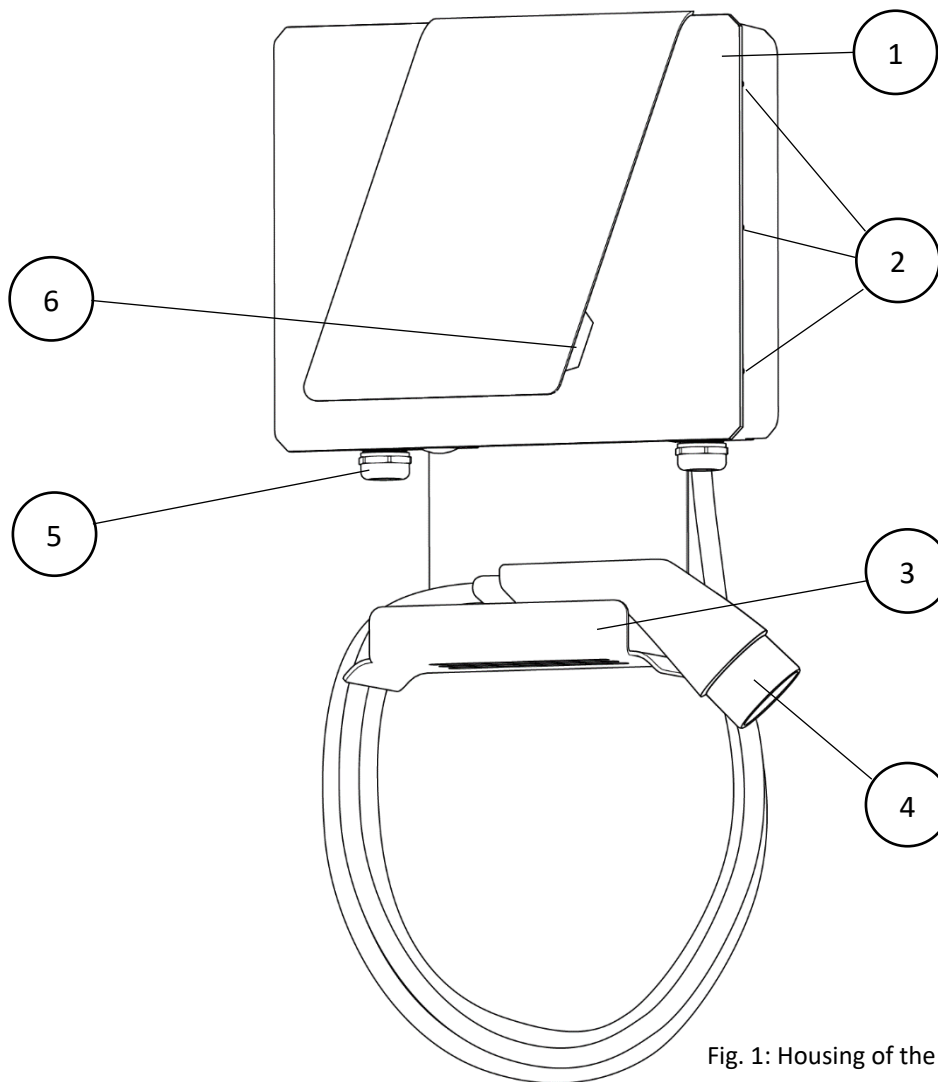

Fig. 1: Housing of the charging station outside

1	Charger housing	4	Charging cable with coupling
2	Cover screw connection	5	Power cable connection
3	Holder for charging cable	6	LED display

3.2 Function

The LRT Home Essential is a three-phase charging station for charging electric vehicles according to charging mode 3 as per IEC 61851 with alternating current (AC).

Functional element	Function
Type 2 cable	Coupling for connecting the vehicle
LED display	Status display of the charging station
RCCB type B (only with AC07C, AC08C)	Fuse

3.3 Technical data

General data

Model	Home Essential 11	Home Essential 22
Part number	AC07C, AC07CoFI	AC08C, AC08CoFI
Housing dimensions LxWxH	48x36x13 cm	
Housing material	PC/ABS V0 + MB	
Weight	7.14 kg	
Cable length	5 m	

Electrical

Model	Home Essential 11	Home Essential 22
Charging mode	Mode 3 – C	
Three-phase alternating current	3P + N + PE	
Supply voltage	400 V AC \pm 10 %	
Mains frequency	50/60 Hz	
Max. current	16 A	32 A
Max. charging power	11 kW	22 kW
Overvoltage category	III	
Charge coupling	Charging cable type 2 IEC 62196	
RCCB with AC07CoFI, AC08CoFI	must be installed on the building side	
RCCB with AC07C, AC08C	AC 30 mA, DC 6 mA, type B RCCB	
Connection with AC07CoFI, AC08CoFI	3phase to terminal	
Connection with AC07C, AC08C	3phase to RCCB	
Protection class	IP44	

Ambient conditions

Model	Home Essential 11	Home Essential 22
Ambient temperature	-40 °C – 45 °C	
Storage temperature	-40 °C – 70 °C	
Max. humidity	5 % – 95 %, non-condensing	
Max. height above sea level	2000 m	

4 Installation

Have the charging station installed and secured by a qualified electrician in accordance with local safety regulations and legal requirements.



Warning of dangerous electrical voltage!

Touching electrical cables can result in a fatal electric shock.

- Only use the charging station after it has been commissioned by a qualified electrician.

NOTE



Observe the installation instructions.

For installation by a qualified electrician, please refer to the installation instructions LRT Home Essential 11/LRT Home Essential 22.

5 Operation



Warning of dangerous electrical voltage!

Touching electrical cables can result in a fatal electric shock.

- Only use the charging station after it has been commissioned by a qualified electrician.
- Do not touch the plug connection on the charging cable, only on the coupling of the charging cable.
- When charging is complete, always close the protective cap at the end of the charging cable coupling.

Requirements

- LED indicator flashes blue: The charging station is ready for charging.
- The vehicle is stationary.
Do not charge the electric vehicle when it is moving. It must come to a complete stop before charging is started and must not move during charging.

Check the following points before each charging process:

- Is the charging station firmly connected to the wall?
- Is the housing undamaged and closed?
- Is the charging cable undamaged?
The sheathing must not be cracked and no metal must be exposed.

If the answer to any of the three questions is no, immediately turn off the power to the charging station and contact an electrician or customer service for repair work.

- Is the coupling of the charging cable clean and dry?
If the charging cable coupling is wet or dirty, it can be cleaned with a clean and dry cloth.

Charging the vehicle

Plug the coupling of the charging cable into the socket on the vehicle side. The LED status indicator lights up blue as soon as the vehicle is connected to the charging station. During the charging process, the LEDs light up green.

→ The vehicle locks the charging coupling and requests charging. As long as the charging process is running, the charging coupling is locked. The charging cable can only be unplugged after the process has been completed/cancelled.

Ending the charging process

When the vehicle is fully charged, the vehicle stops charging and releases the charging cable coupling.

- Unplug the coupler from the vehicle-side socket.
- Close the protective cap at the end of the coupling of the charging cable.
- Wind up the charging cable on the holder of the charging station.

Cancelling the charging process

The charging process can be cancelled if the driver wants to use his vehicle before it is fully charged.

There are two options for cancelling the charging process:

- via the controls in the vehicle,
- by switching off the fuse on the building side.

The process should be cancelled using the controls on the vehicle. Only if this is not possible for safety reasons (e.g. if the vehicle is on fire) should the building security system be switched off.

Charging will resume when the fuse is turned back on and the charging cable is connected to the vehicle.

Malfunction or failure

In the event of a fault or failure, disconnect the charging station from the supply voltage by switching off the fuse on the building side. Contact a qualified electrician for the repair work.

NOTE



If the building or wallbox fuse trips, do not simply switch it back on. This may result in damage to the charging station, the vehicle, etc.

- Disconnect the vehicle from the charging station.
- Find and eliminate the reason for tripping - if necessary, by a qualified electrician.

The fuse can then be switched on and the charging station reconnected to the vehicle.

Meaning of the LED display

LED display	Operating status
Blue flashing	Ready to connect
Lights blue	Connected to vehicle
Lights green	Charging in progress
Lights red	Overheating, cancel charging
Red flashing	Malfunction, charging process cancelled

6 Maintenance/Cleaning

6.1 Testing the safety function

Have the safety function of the charging station checked twice a year by a qualified electrician.

6.2 Cleaning

Wipe the housing and the cable holder with a damp cloth. Do not use aggressive cleaning agents. They can attack the plastic parts.

Do not clean the vehicle or the area around the charging station with a pressure washer while the vehicle is connected to the charging station. The plug connection and the charging station are not resistant to pressurised water.

7 Disposal

The charging station is a device that must be disposed of in accordance with national and regional regulations for waste electrical and electronic equipment.

Have the charging station dismantled and disposed of by a qualified electrician.

8 CE Declaration of Conformity

EU-Konformitätserklärung gemäß der EU-Niederspannungsrichtlinie 2014/35/EU, Anhang IV

Hiermit erklären wir, dass die Bauart des

Erzeugnis: Ladesystem Mode 3
Modell: LRT Home Essential 11 und Home Essential 22
Hersteller: LRT Automotive GmbH, Impexstrasse 7, 69190 Walldorf

Folgenden einschlägigen Bestimmungen entspricht:

Niederspannungsrichtlinie 2014/35/EU
EMV-Richtlinie 2014/30/EU
RoHS-Richtlinie 2011/65/EU

Angewandte harmonisierte Normen, insbesondere:

EN61851-1: 2011
EN 61000-3-2: 2014
EN 61000-3-3: 2013
EN 62196-1: 2014
EN 62196-2: 2017

Die Konformitätserklärung bezieht sich auf den Auslieferungszustand des Ladesystems.

06.05.21, Walldorf

Datum/Ort

LRT Automotive GmbH
Impexstraße 7
69190 Walldorf / Baden
Tel: 06227/63892 Fax: 06227/63715
Stefan Wenzel (Managing Director)



LRT Automotive GmbH
Impexstraße 7
D-69190 Walldorf

©2021, all rights reserved